

0A - 0F

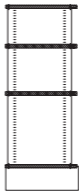

142
55.9"



52 33 27
20.5" 13.0" 10.6"

69-75
27.2-29.7"

53
21.0"

117
46.1"



55
21.8"

2B - 2G

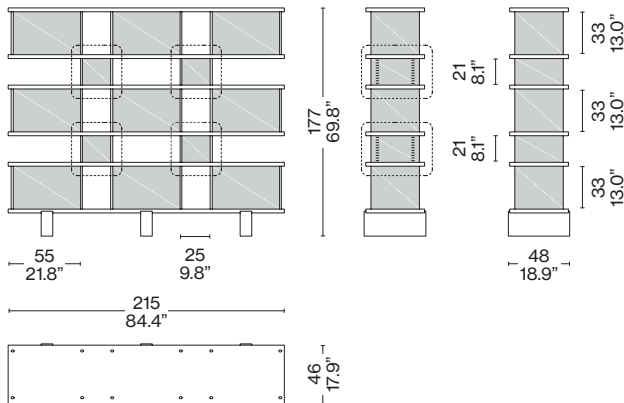

5B - 5G

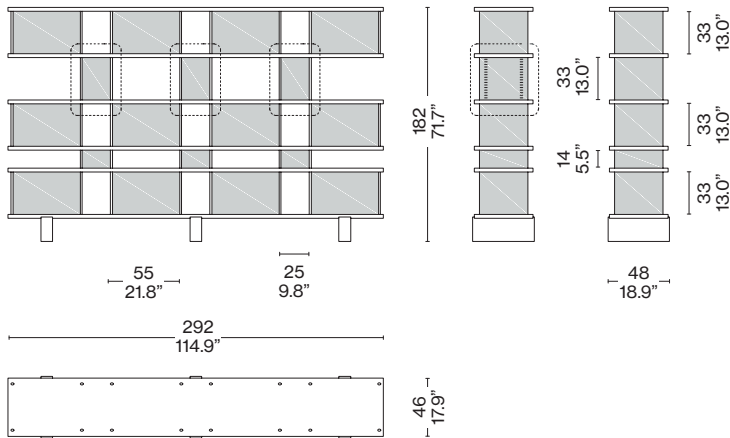

OC - 0H

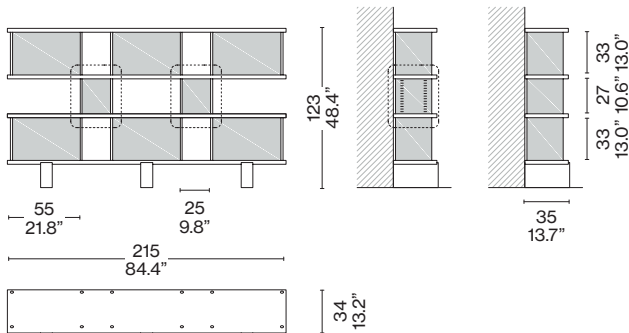

2C - 2H

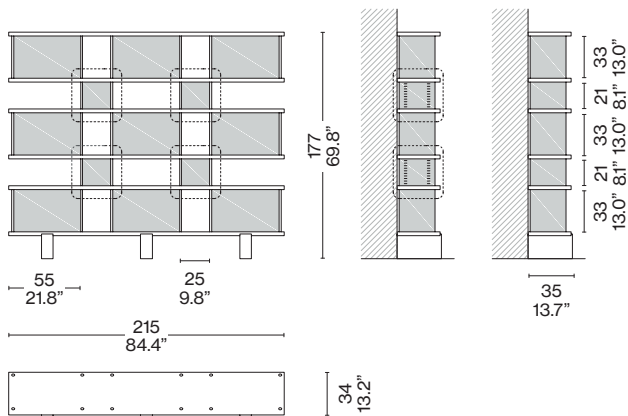

6C - 6H

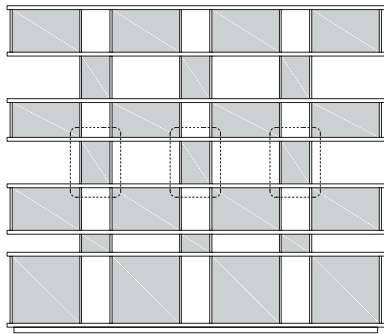

55
21.8"

25
9.8"

292
114.9"

254
99.8"

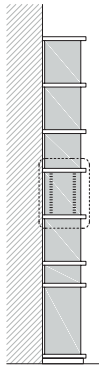

27
10.6"

14
5.5"

33
13.0"

33
13.0"

52
20.5"



34
13.2"

2D - 2I

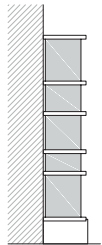
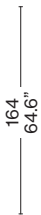
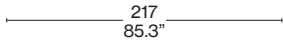
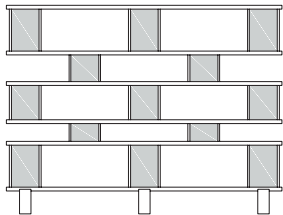

0E - 0J

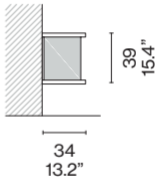
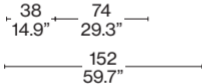

3E - 3J

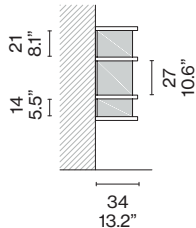
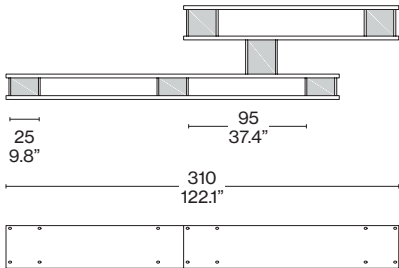

3M

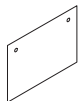
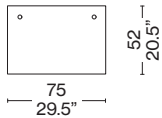

4M

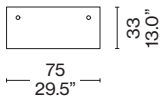

5M

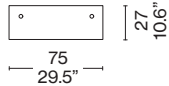

3M / 4M / 5M

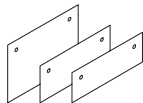

3N

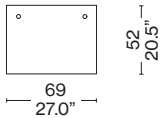

4N

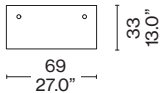

5N

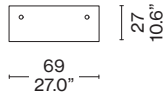

3N / 4N / 5N

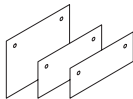

01

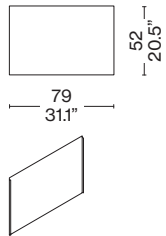

1P

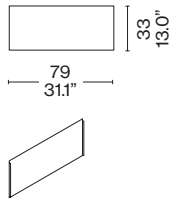

2P

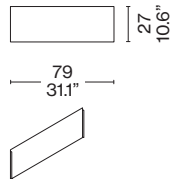

3P

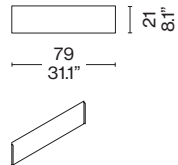

4P

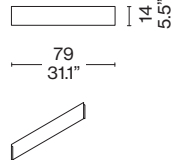

0P / 1P / 2P / 3P / 4P

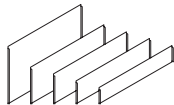

T0

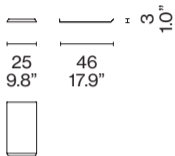

T1



T0 / T1

